

Metrology



INSTRUCTION MANUAL

SD1 Dial Gauge

Document No. : D1F421 010
Edition : January 2020
© Copyright : IBR



Messtechnik GmbH & Co. KG



Contents

1. Technical Data	3
2. Dimensions	4
3. Connecting probes	5
4. Display	6
5. Programming Menu	7
6. Measuring Mode	13
7. Instructions for battery replacement	14
8. PC connection	15
9. Windows configuration software SD1_Win.exe	16
10. Safety Instructions	17
11. Declaration of conformity	18
12. Guarantee	18



1. Technical Data

Mechanical characteristics

Case	Aluminium, rubber shock protection
Front plane	Acryl glass (scratch proof)
Dimensions / Weight	(W x H x D) 60 x 59.5 x 21,7 mm / 95 g

Electrical characteristics

Power supply	Battery (CR2032)
Battery lifetime	approx. 8000 h (SD1 with probe)
Measuring rate	adjustable, 2 ... 20 values / sec

LCD display

Display type	Liquid crystal display, reflective
Numeric display	7 digits (10,5 mm)
Analogue display	53 segments

LEDs / Acoustical output

Tolerance display	3 LEDs : 1x red, 1x green, 1x yellow
Buzzer	Piezo

Connections

ISi interface	Bus connection for sensors, hand / foot switch, tolerance adapter, ...
Triple-I interface	Connection for IBR radio modules or cable with USB / RS232 interface

Measuring systems

The measurands : measuring range, resolution, precision, ... are defined by the connected measuring probe or sensor.

Example : Measuring probe IMS-5S → Range 5mm, Resolution 0.01µm

Environmental conditions

Operation / Storage temp.	+41 ... +113 °F / -4 ... +158°F
Protection class	IP65 (CEI / IEC 529)

EMC according to EN50081-2 and EN50082-2



2. Dimensions

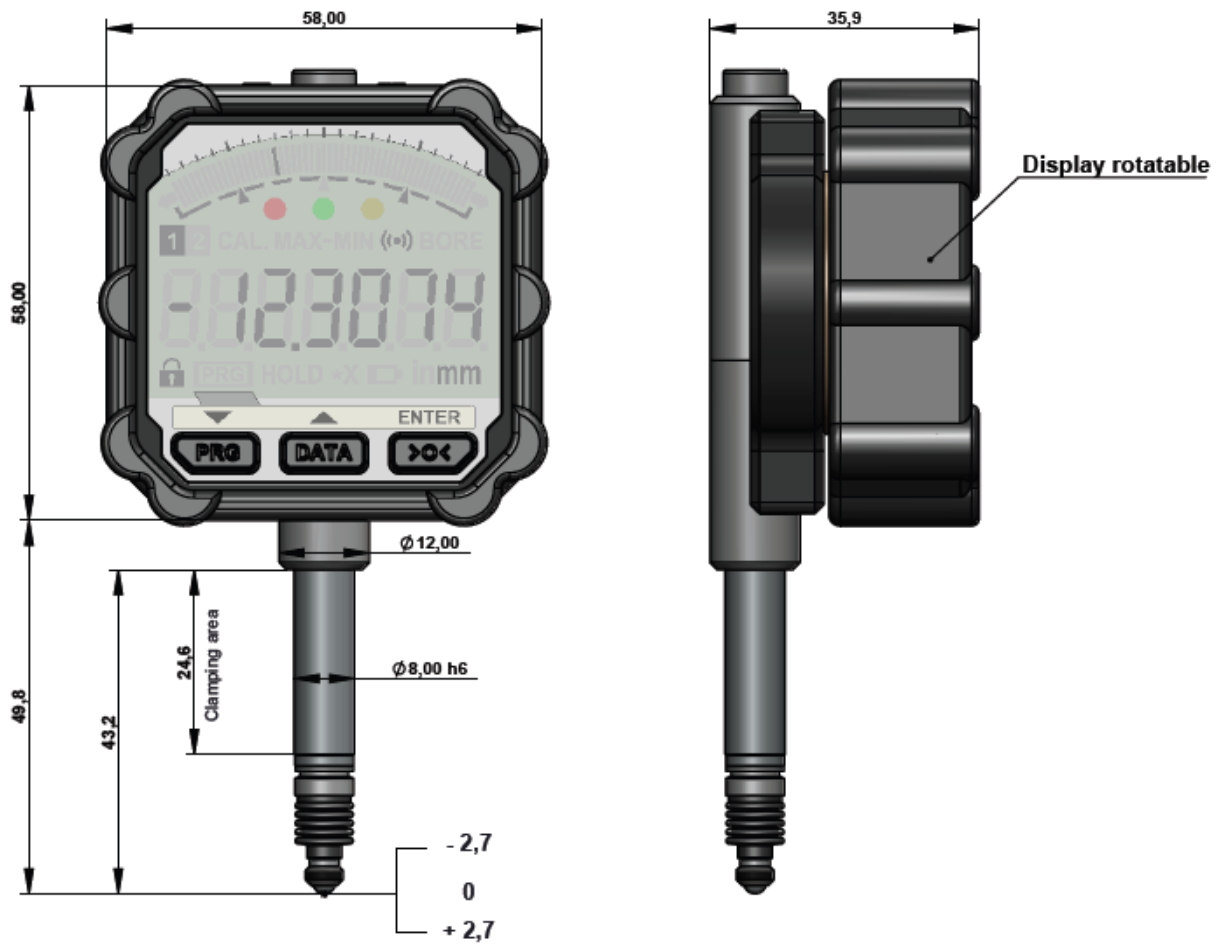

3. Connecting probes

Variant A

→ Usage as dial gauge

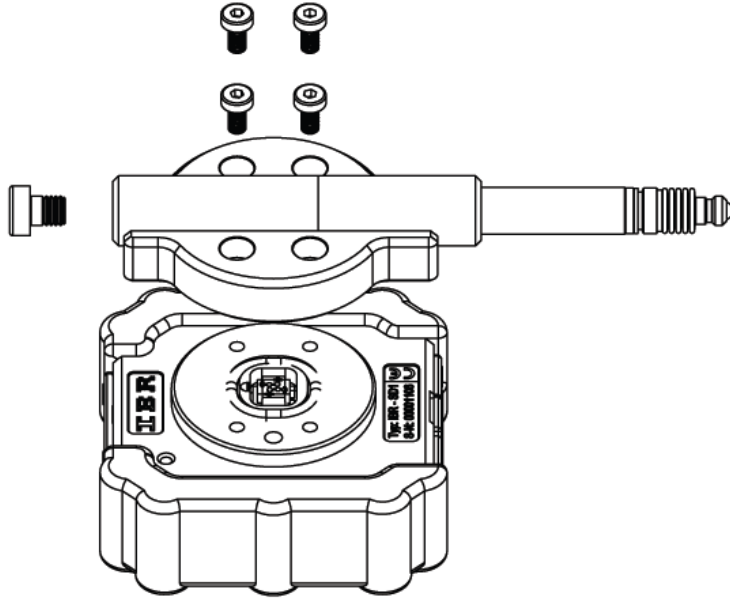

Variant B

→ Connection of up to 2 probes and an additional hand / foot switch





4. Display



- 1. Calibration request
- 2. Tolerance LEDs
- 3. Column display
- 4. Data transmission
- 5. Dynamic measuring mode
- 6. Numeric display
- 7. Unit
- 8. Battery display
- 9. Factor defined
- 10. Function „Hold“
- 11. Programming menu
- 12. Passcode set
- 13. Measuring probe 1 / 2

A detailed description can be found in chapter 6 “Measuring Mode”.



5. Programming menu

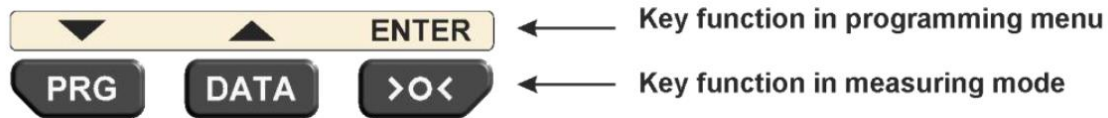

Open the programming menu by pressing the PRG button.

The following settings are available :

Note : The access to the settings via the programming menu can be restricted by using the Windows configuration software SD1_Win.exe (→ see chapter 9).
Because of this, there may not be all of the following menu options available.

Overview :

- Unit Selection of unit
- rESoL. Selection of resolution
- dir. Selection of measuring direction
- PrESEt Zeroadjustment / Preset
- 2-CAL. 2 Master calibration
- dt.-CAL. Temperature forced calibration (in steps of 0.5 °C)
- tF.-CAL. Timer forced calibration (in steps of 30 min)
- FActor / ProbES (*) Measuring input A and B
- SEt.OP. Selection of a Measuring mode
- GrAdinG Selection of a Grading mode
- SEt.Pnt. (*) Input of the nominal value with relative tolerances
- SEt.toL. (*) Input of absolute tolerances
- toL.LED Tolerance LEDs
- CoL.diS. Analogue display
- hoLd Freezing of the display on a static measurement
- but.PRg. Assign a second function to the PRG button
- but.dAtA. Assign a second function to the DATA button
- but.CAL. Assign a second function to the >O< button
- FootS. Assign a function to a hand / foot switch
- P.C.ProG. Passcode for the programming menu (4 digits)
- P.C.CAL. Passcode for the calibration (4 digits)
- Auto.oFF Setting the Auto Power Off time
- SA.rAtE Setting the measurement rate
- BEEP Button tone
- ProG.End Leave the programming menu

Note : The selection of the active menus (marked with (*)) is only possible with the Windows configuration software SD1_Win.exe (→ see chapter 9), not with the programming menu of the SD1.



Basic function / Selection of the unit



Basic function / Selection of the resolution



Basic function / Selection of the measuring direction



Calibration / Zeroadjustment & Preset



Note :
 All digits have to be set one by one with the buttons **PRG** and **DATA**. The change to the next digit is done by pressing the button **>O<**. If the button **>O<** is pressed > 2 sec., the complete number is confirmed regardless of which digit is active at the moment.

Calibration / 2 Master calibration



Calibration / Temperature forced calibration

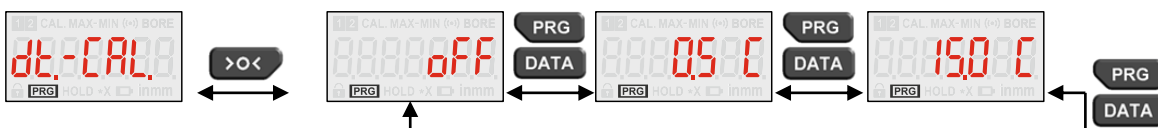

Calibration / Timer forced calibration

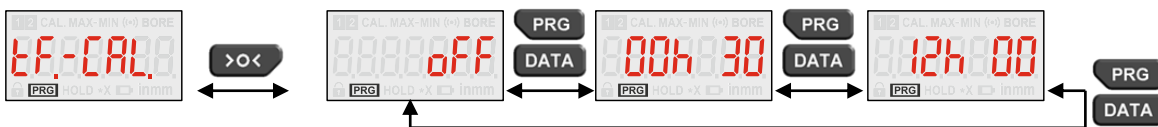

First display variant, if only one probe was selected in the basic settings:





Second display variant, if both probes were selected in the basic settings :

Submenu for the selection of a probe



Submenu for the activation / deactivation of the probe with input of a factor

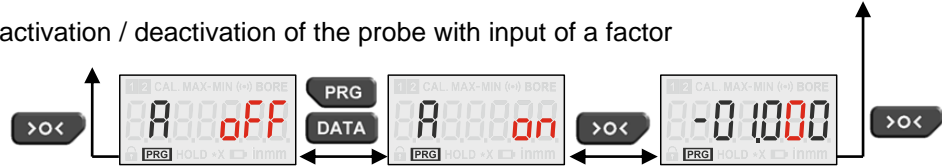

Measuring modes

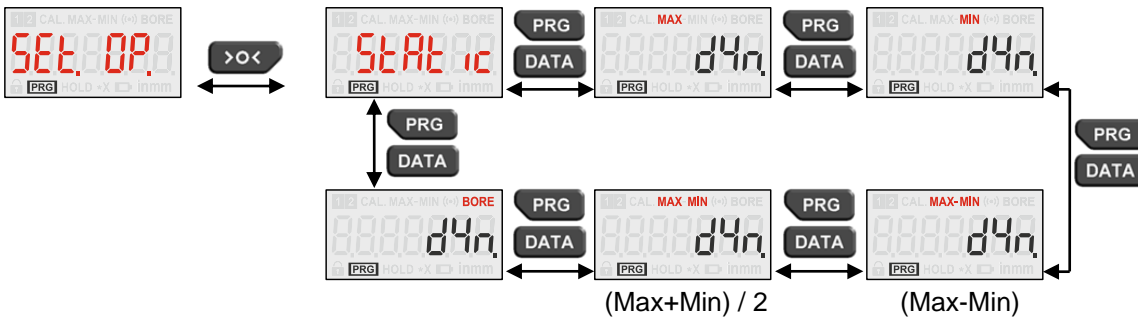

Grading mode / Number of grades [Off...30]

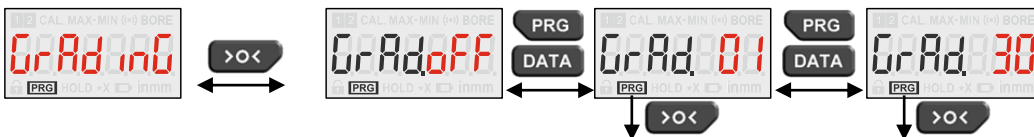

Grading mode / Display of grade on numeric display on / off



Tolerance limits / Nominal value

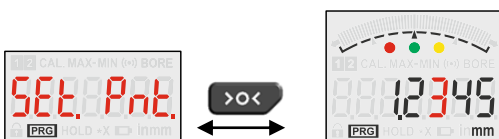

Note :
 All digits have to be set one by one with the buttons **PRG** and **DATA**. The change to the next digit is done by pressing the button **><**. If the button **><** is pressed > 2 sec., the complete number is confirmed regardless of which digit is active at the moment.





Tolerance limits / Tolerances

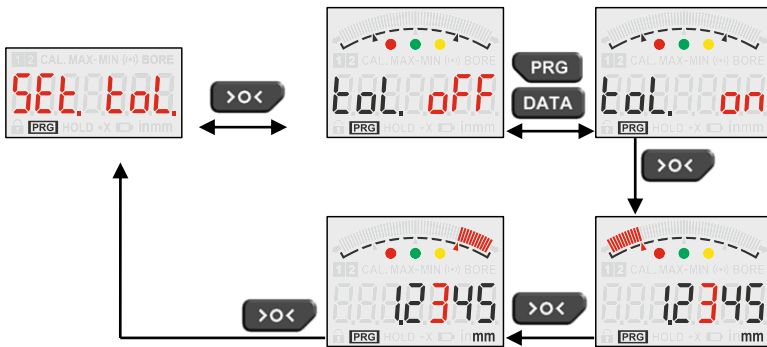

Note :
 All digits have to be set one by one with the buttons **PRG** and **DATA**. The change to the next digit is done by pressing the button **><**. If the button **><** is pressed > 2 sec., the complete number is confirmed regardless of which digit is active at the moment.

Tolerance LEDs / Exceeding upper tolerance limit and lower tolerance limit

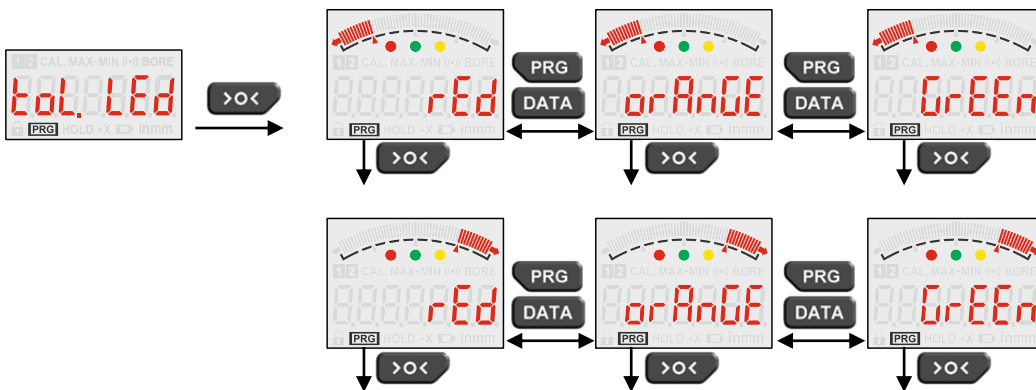

Tolerance LEDs / Display time

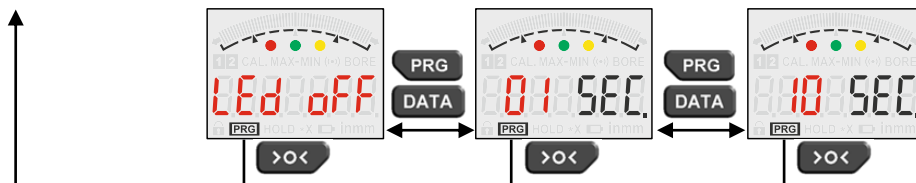

Column display / Selection of the column display mode



Column display / Column starting point

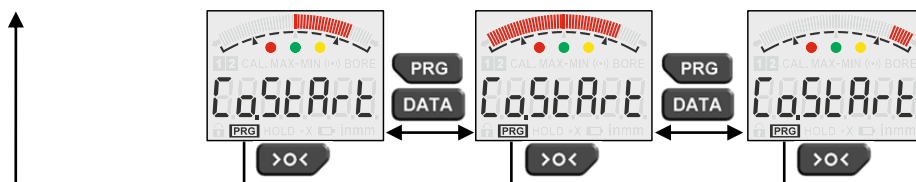



Display control / Freezing the display on a static measurement



Favourite buttons / PRG button pressed > 2 seconds in measuring mode

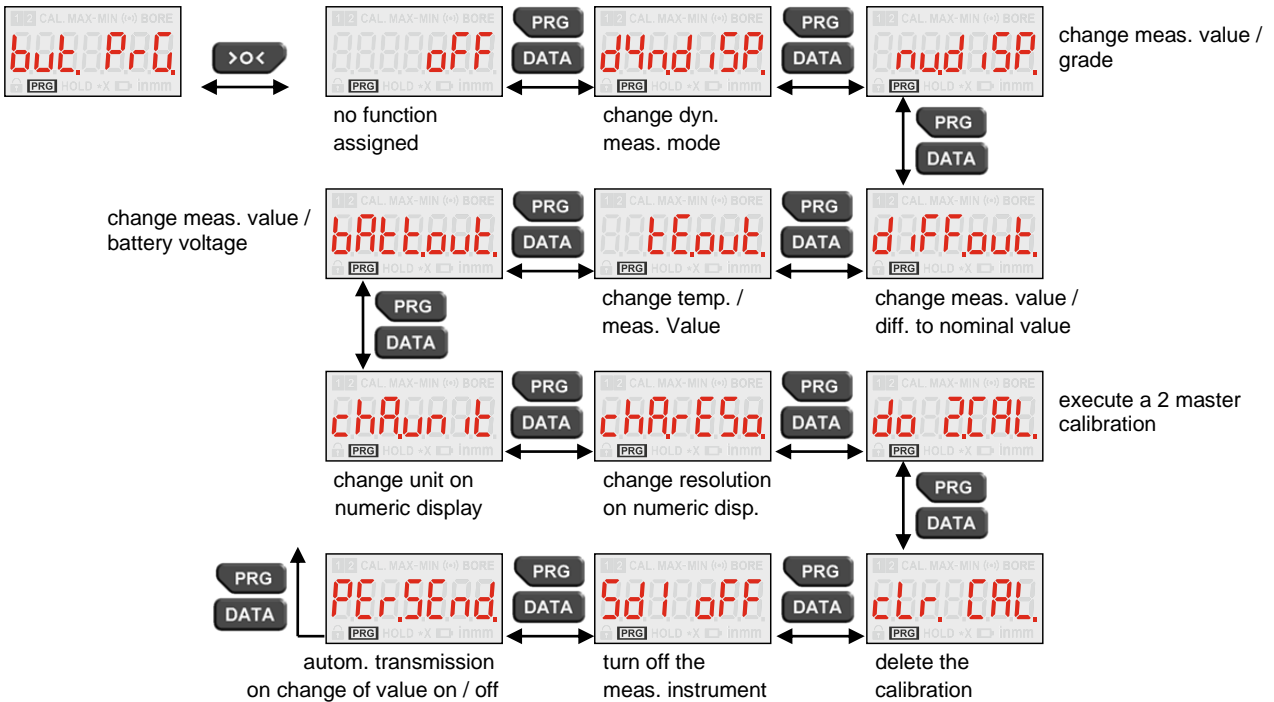

Favourite buttons / DATA button pressed > 2 seconds in measuring mode



Favourite buttons / >O< button pressed > 2 seconds in measuring mode



Hand / foot switch : Selection of the function

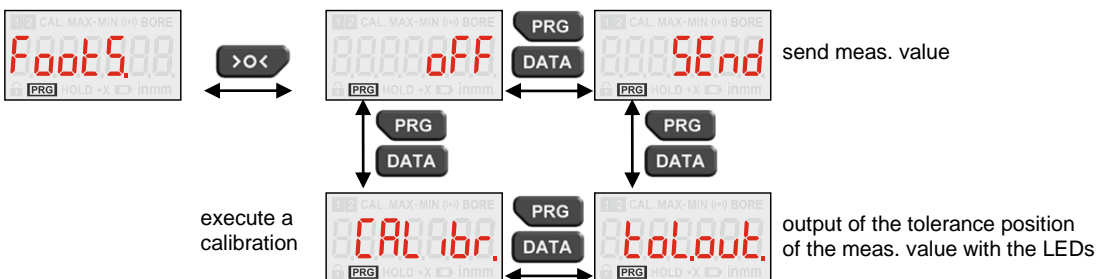



Passcodes / Passcode for Programming menu

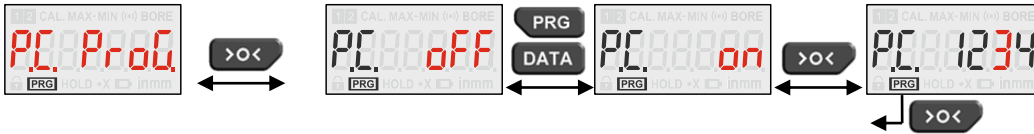

Passcodes / Passcode for calibration

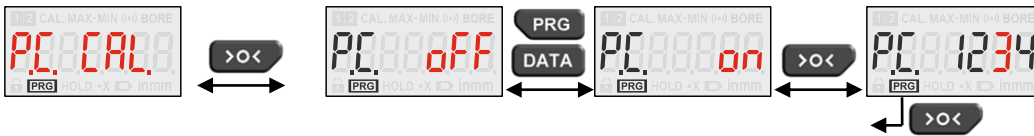

Special parameter / Auto Power Off time

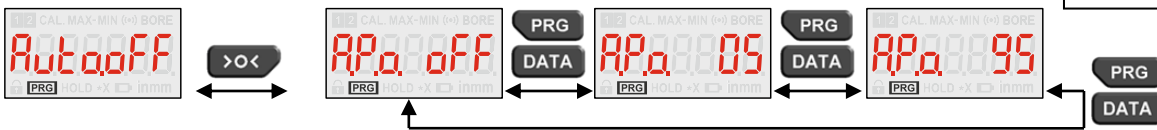

Special parameter / Measuring rate

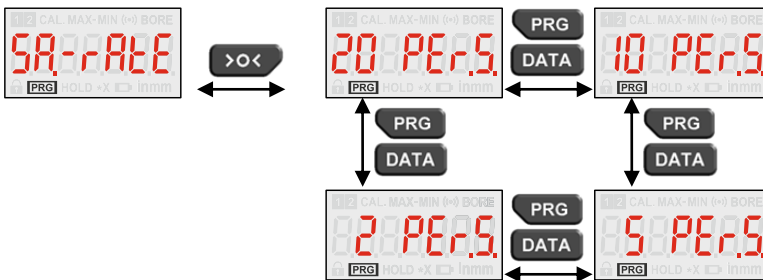

Special parameter / Button tone



Leave the Programming menu



Note :
 All digits have to be set one by one with the buttons **PRG** and **DATA**. The change to the next digit is done by pressing the button **><**. If the button **><** is pressed > 2 sec., the complete number is confirmed regardless of which digit is active at the moment.



6. Measuring mode

Key functions in :		Measuring mode
		Call programming menu
> 2 sec.		<i>Freely programmable favorit key</i>
		Data transfer Start / Stop dynamic measurement
> 2 sec.		<i>Freely programmable favorit key</i>
		Zero adjustment
> 2 sec.		<i>Freely programmable favorit key</i>

Note : During a static measurement the measuring value is transmitted by pressing the DATA button.

During a dynamic measurement the measuring values transmitted when the dynamic measurement is **ended** with the DATA button.

When and are pressed together for more than 2 seconds, all settings are returned to Default.

The default passcode is **9837** on calling the programming menu.

Description of the display elements

- | | |
|---------------------------|---|
| 1. Calibration request | → blinks at temp. / time contolled calibration (a data transmission is not possible) |
| 2. Tolerance LEDs | → light when the DATA button is pressed |
| 3. Column display | |
| 4. Data transmission | → Standard mode : blinks shortly when DATA button is pressed
Permanent mode : is lighted permanently |
| 5. Dynamic measuring mode | → blinks while a dynamic measurement is running |
| 6. Numeric display | |
| 7. Unit | |
| 8. Battery display | → Segment off = Battery okay
on = Battery low
blinking = Battery critical |
| 9. Factor defined | |
| 10. Function „Hold“ | |
| 11. Programming menu | |
| 12. Passcode set | |
| 13. Measuring probe 1 / 2 | |





7. Instructions for battery replacement



Battery type : CR2032

8. PC connection

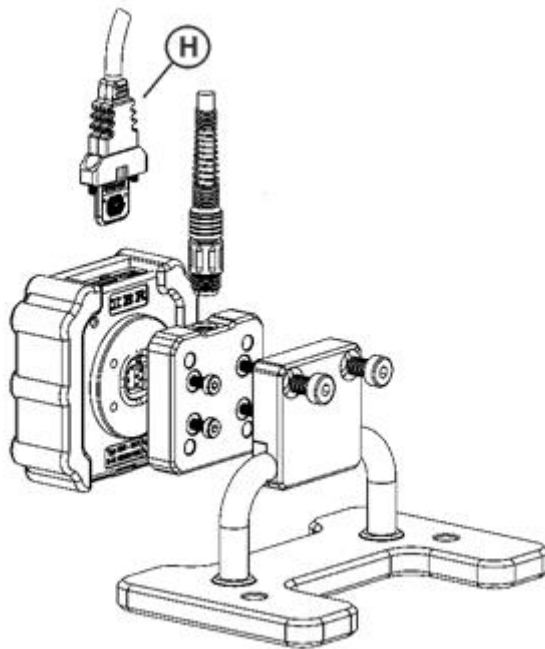

Ⓜ 3i-USB

[F420 010] Triple -I connection cable for USB interface



Ⓜ 3i-232

[F420 020] Triple -I connection cable for RS232 interface





9. Windows configuration software SD1_Win.exe

The software *SD1_Win.exe* allows the programming of SD1 dial gauges by using a PC :

- Online programming of SD1 dial gauges
- Definition of configurations (= test schemes)
- Saving of configurations from SD1 dial gauges to a file
- Loading of configurations from a file into SD1 dial gauges
- Menu for performing firmware updates.

Note : The SD1 has to be activated and must not be in the programming menu.
Else, no connection can be established.

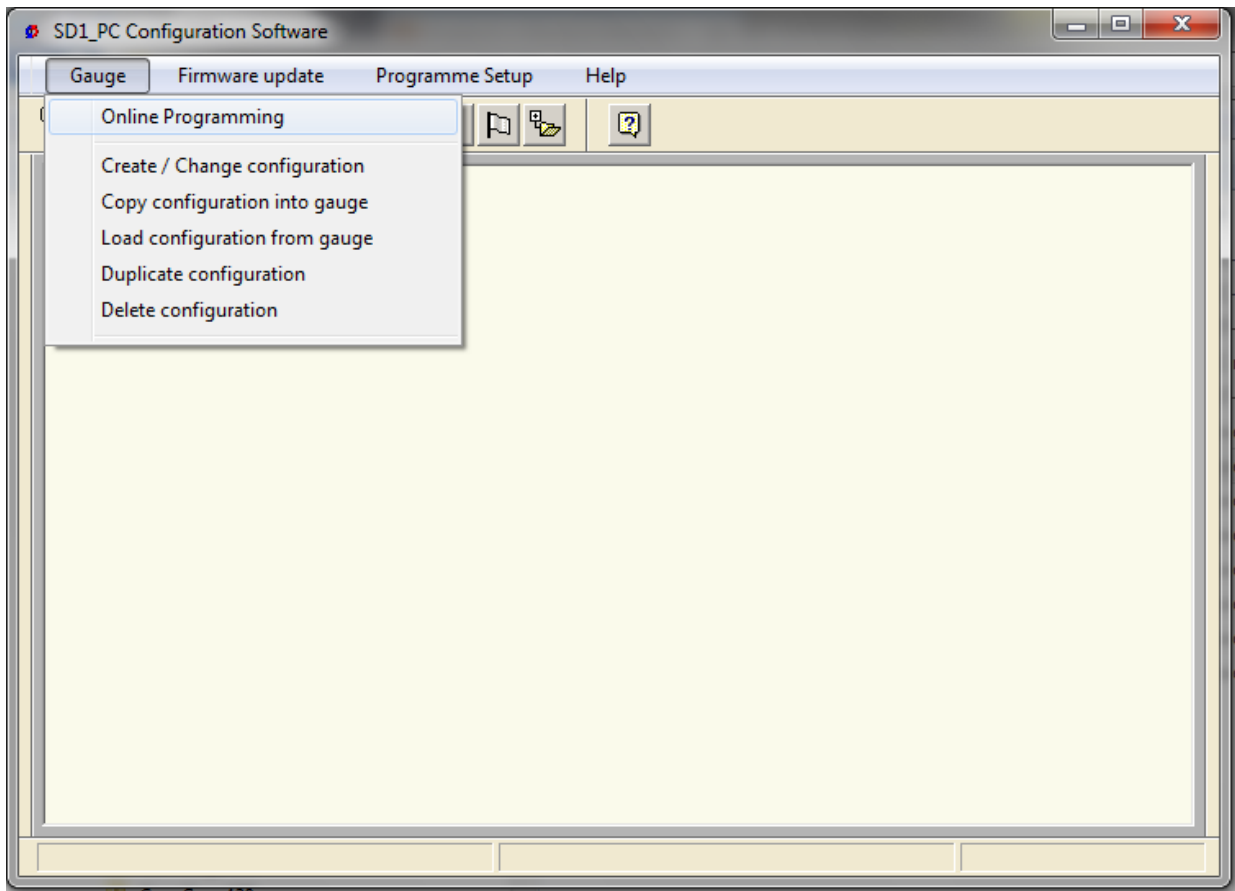

By the red-marked selection boxes the programming menus inside the SD1 can be switched on / off.
By the blue-marked edit boxes the settings in SD1 can be programmed.

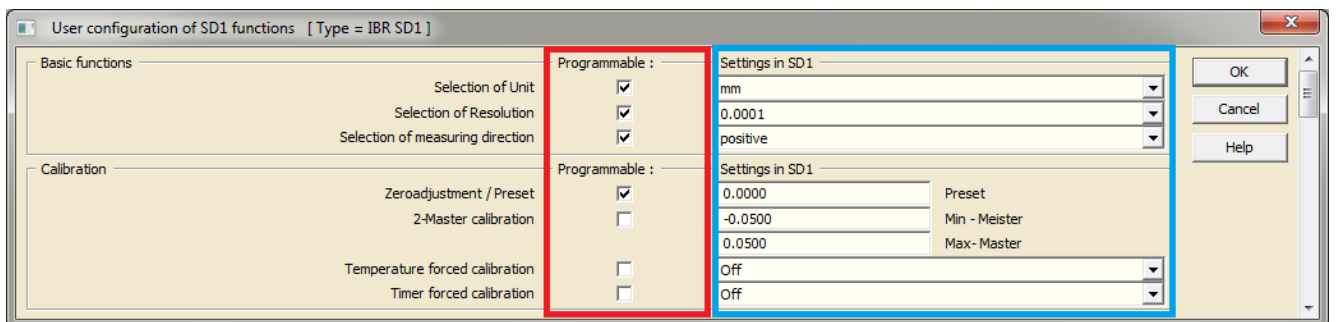



10. Safety instructions

The instrument has been designed and manufactured according to the state of the art and approved technical safety regulations. It is nevertheless mandatory to observe the following instructions in order to prevent personal injuries or accidental death of staff members and other persons.

1. All operators must read the present instructions and this manual very carefully **prior to starting operation**.
2. The instrument may be used only **in proper operational** condition. Malfunctions or errors that may potentially impair the operational safety must be eliminated immediately.
3. The instrument is to be used only for its intended purpose and according to the Instruction Manual. The Instruction Manual is to be kept near the place of operation and ready for use.
4. Prior to connecting the instrument to the power outlet, make sure that the voltage indicated on the label corresponds to the voltage of the local mains. If this is not the case, the device should under no circumstances be connected to the power outlet!
5. The instrument must be connected to the power supply through a properly grounded safety socket. Extension cables, if required, must comply with VDE safety standards.
6. Any modification to or change in procedures concerning the instrument is permitted only with the prior written consent of IBR Messtechnik GmbH & Co. KG and must be carried out by trained staff. Unauthorised opening of the instrument or tampering with the device shall void the guarantee and exempt the manufacturer from any liability. Before opening the instrument, make sure to effectively cut the power supply, e.g. by disconnecting the power cable.
7. Disconnect the instrument from the mains prior to cleaning. Never let any liquids penetrate the inside of the instrument. Do not use cleaners that dissolve plastic.
8. Replace faulty fuses only with fuses of **identical** amperage and current characteristics following the instructions given in this manual.
9. Corporate guidelines and safety regulations enforced by the industrial trade associations for the prevention of industrial accidents must be strictly observed. Make sure to consult the safety officer at your company.
10. Do not operate the instrument in an environment containing explosive gases, because an electric spark can cause an explosion.

We reserve the right to change the design and technical data contained in our documentation without notifying our customers. IBR is not obliged to notify buyers of product changes.

IBRit is a registered trademark of IBR.

Windows and **EXCEL** are registered trademarks of Microsoft Corporation.

This document must not be reproduced, in part or in its entirety, without the prior written consent from IBR.



11. Declaration of conformity

Thank you very much for your confidence in purchasing this product. We herewith certify that it was manufactured and inspected in our works.

We declare under our sole responsibility that this product is in conformity with technical data as specified in this instruction manual.

Furthermore, we certify that the measuring equipment used to check this product refers to national master standards. The traceability of measuring values is guaranteed by our Quality Assurance System.

12. Guarantee

The quality of this instrument is guaranteed for a period of 12 months from the date of delivery. This guarantee covers all material and manufacturing defects.

Our liability is limited to product repair services or, should we deem it necessary, replacing or crediting the goods.

This guarantee does not include the batteries or damage due to:

- ◆ *Disregard of operating instructions*
- ◆ *Incorrect handling*
- ◆ *Tampering by unauthorised staff*
- ◆ *Attempts by any unauthorised person to repair the instrument.*

We are not to be held liable for any subsequent damage caused by, directly or indirectly, the instrument or its use.

Notice : If you are returning the instrument under guarantee, please use the original packaging.

Should you detect an irregularity of any kind, please contact one of our authorised distributors or our service department.

D-36166 Haunetal, March 28th, 2019

I B R Messtechnik GmbH & Co. KG