

(2:1)

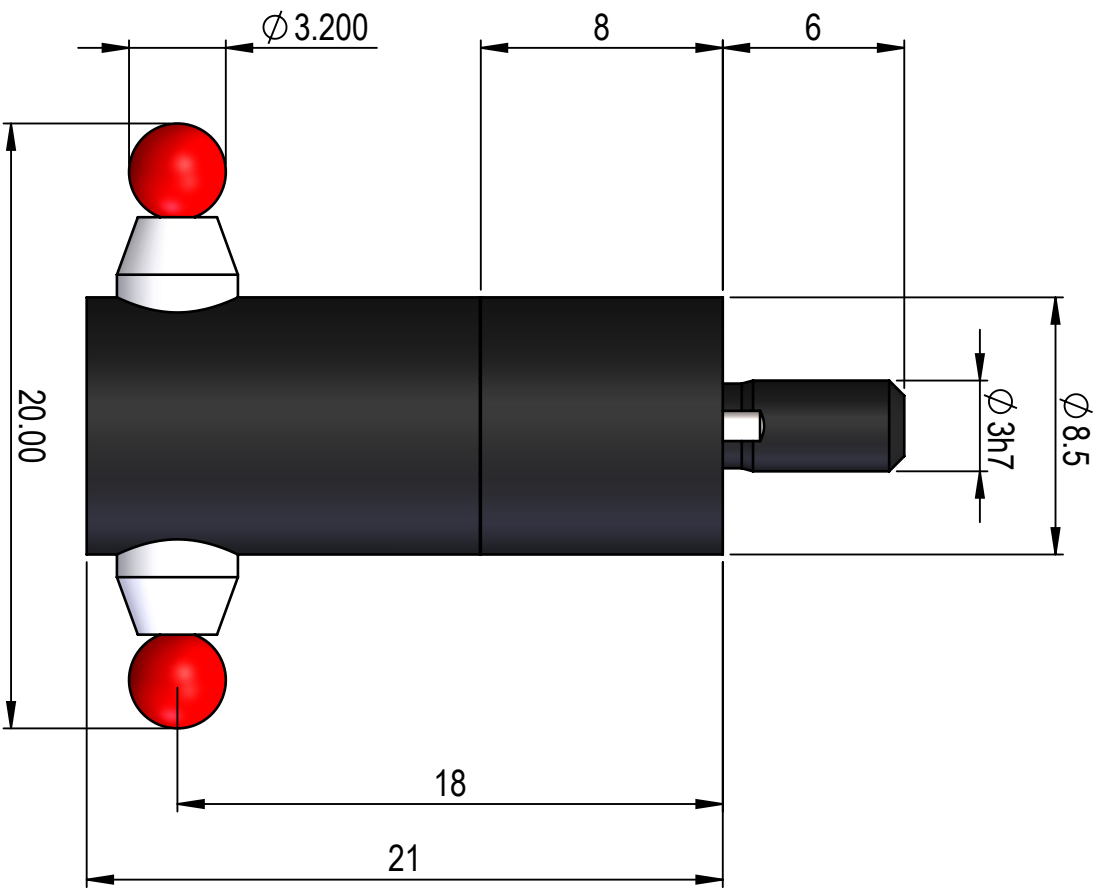

Size 11 90°

Scale
4:1
mm

