

(2:1)

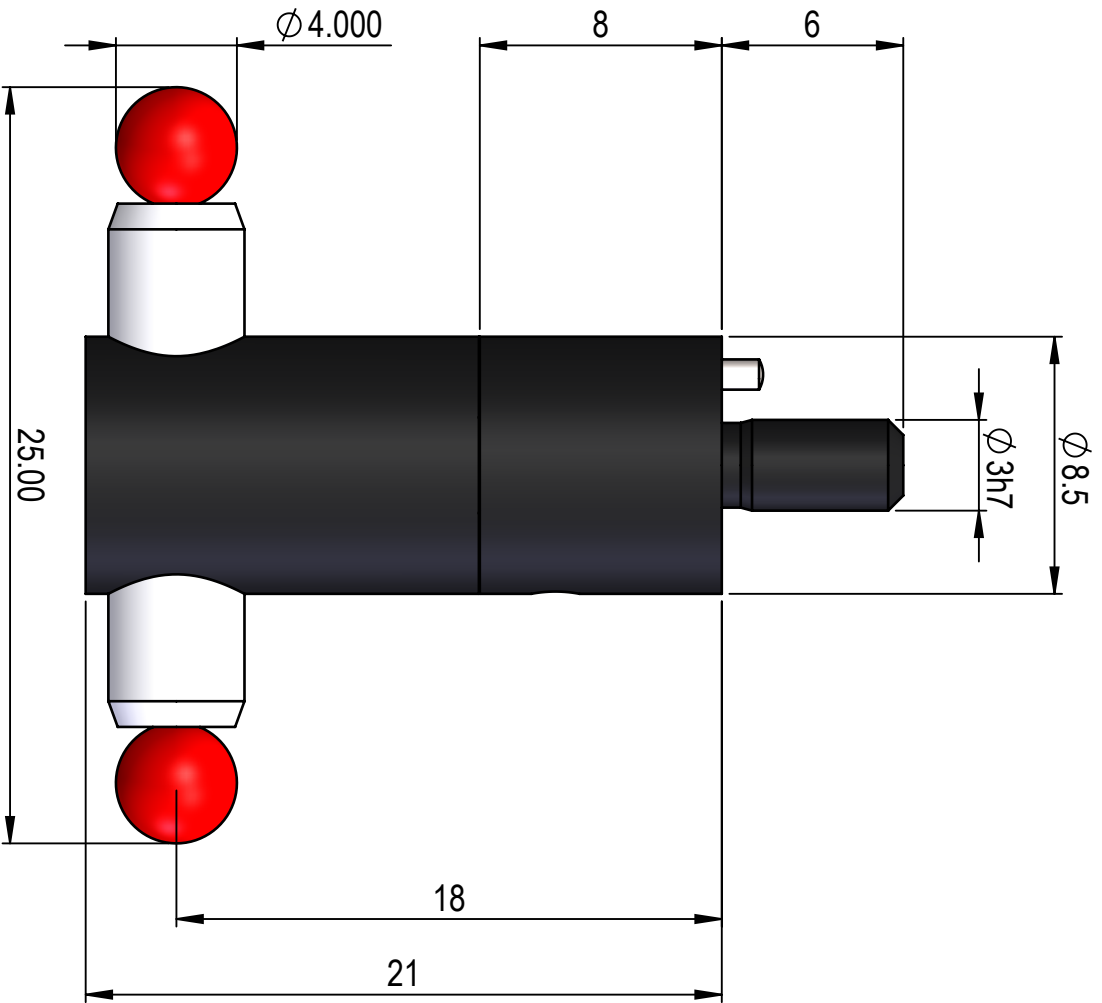

Size 12 parallel

Scale
4:1
mm

