

(2:1)

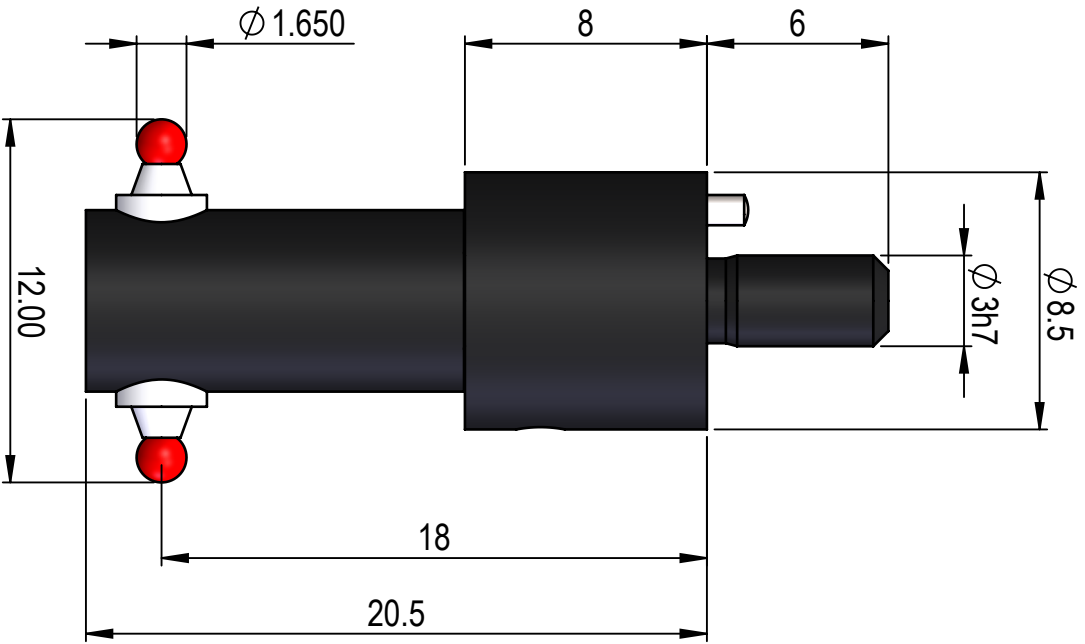

Size 8 parallel

Scale  
4:1  
mm

